

See discussions, stats, and author profiles for this publication at: <https://www.researchgate.net/publication/330901946>

Selecting the Most Efficient Bearing of Wind Turbine Gearbox Using (Analytical Hierachy Process) Method AHP

Conference Paper · February 2019

CITATIONS

0

READS

496

3 authors:



Tahseen Ali Mankhi

Poznan University of Technology

5 PUBLICATIONS 5 CITATIONS

[SEE PROFILE](#)



Stanislaw Legutko

Poznan University of Technology

151 PUBLICATIONS 2,090 CITATIONS

[SEE PROFILE](#)



Jasim AL-Bedhany

University of Misan/ Engineering College

9 PUBLICATIONS 7 CITATIONS

[SEE PROFILE](#)

Some of the authors of this publication are also working on these related projects:



Scientific Hypothesis as a source of innovation and discovery [View project](#)



A new life prediction theory of wind turbine gearbox bearings using operating condition data [View project](#)

PAPER • OPEN ACCESS

Selecting the Most Efficient Bearing of Wind Turbine Gearbox Using (Analytical Hierarchy Process) Method “AHP”

To cite this article: Tahseen Ali Mankhi *et al* 2019 *IOP Conf. Ser.: Mater. Sci. Eng.* **518** 032050

View the [article online](#) for updates and enhancements.



IOP | ebooks™

Bringing you innovative digital publishing with leading voices to create your essential collection of books in STEM research.

Start exploring the collection - download the first chapter of every title for free.

Selecting the Most Efficient Bearing of Wind Turbine Gearbox Using (Analytical Hierarchy Process) Method “AHP”

Tahseen Ali Mankhi^{1*}, Stanislaw Legutko², Jasim H Al-Bedhany³ and Abdulmuttalib A. Muhsen¹

¹Faculty of Transport Engineering, Poznan University of Technology. ul. Piotrowo 3, 60-965 Poznań, Poland.

²Faculty of Mechanical Engineering and Management - Poznan University of Technology, ul. Piotrowo 3, 61-138 Poznań, poland.

³Engineering College -University of Misan, Misan, Iraq.

*Corresponding author e-mail: tahseen227@gmail.com

Abstract. It has been clearly observed that wind turbine energy gearbox bearings are being subjected to premature and unpredicted failure during the first one-fourth duration of their lifespan. This failure is related to many effective factors that have multiple criteria for many available alternative bearings. This article deals with Analytic Hierarchy Process (AHP) and uses a software tool, so called (Expert Choice EC) to select the best compromise solution of the most efficient bearings in wind turbine gearbox. Three types of bearings have been entered in EC comparison: (single-row tapered, single-row cylindrical and double-row cylindrical) roller bearings under five main elements of criteria: (cost, durability, reliability, feature design and availability). Based on the synthesis results and sensitivity analysis of EC software, it can be concluded that single-row tapered bearing is the best choice to be used in wind turbine gearbox of about 52.1% than the other two alternatives taking in considering that the main two criteria, which cause premature failure, are durability and reliability.

1. Introduction

Wind turbine energy is one of the most important green energy that expanded at the last years of this century. The European Wind Energy Agency (EWEA) stated that by 2020, it will be possible to produce 230 GW (which represents about 20% of the total electricity consumption in the European Union) by using wind turbines units [1]. Realistically, number of challenges limited this dream. Some of these limitations concern to wind turbine gearboxes bearings (WTGBs) that subject to failure during (2-5) years of their operational work period. As a result, (WTGBs) could not reach their anticipated lifespan that should be around 20 years. The main shaft with multiple gears of the wind turbine nacelle are carried by large bearings. Gearbox increases the shaft speed of the rotor to a higher speed for the induction generator by using a series of gears (figure 1). As wind turbine gearbox operates from (low speed, high input torque) to (high speed, low output torque), gearbox bearings absorb high transient loads [2]. The environment condition of wind turbine is unstable, so that more extra loads are absorbed by the used bearings and consequently there are many factors that need to be considered when selecting the most suitable type of bearing. According to the Database of the Gearbox Reliability maintained by the National Renewable Energy Laboratory (NREL), the account of bearing failure represents more than 60% of the gearbox failures [3]. As a result, in terms of reliability, it can be considered that gearbox bearings are the most critical component in wind turbine because of their high



premature failure rate and long downtime/failure ratio. [4]. For example, 2 MW class turbine has blades of about 40 meters and a rotor hub of (60 – 100) meters with a total weight of more than 200 tons. Consequently, large bearings should be used with bore diameter of about (240 – 700) mm. The problem becomes more complicated in case of using large (WTGBs) that should be used to increase the produced energy. As a result, the failure rate of (WTGBs) will be more and more.

Relatively, the failure is a recent phenomenon and its modes are still much less understood. White Etching Cracks (WECs) have observed beneath the contact surface of the bearing raceway (figures 2&3) [3][5]. The expected cost for exchanging wind turbine gearbox bearing is about (15000 € for a simple up-tower) and more than (1000000 € for a larger (+5 MW) wind turbine). Maintenance cost for off-shore wind turbine is costly than on-shore one [6]. Analytic Hierarchy Process AHP by using Expert Choice EC method is one of the most valuable tools for selecting the optimum choice among different alternatives with respect to various criteria.

The aim of this work is selecting the most suitable bearing type for wind turbine gearbox by using a software, so called “Expert Choice”. Indicating and choosing the compromise solution among different familiar types of bearings is to prolong the operation duration of wind turbine as much as possible. they should be evaluated under multiple elements of criteria to select the most efficient compromise solution as can as possible.

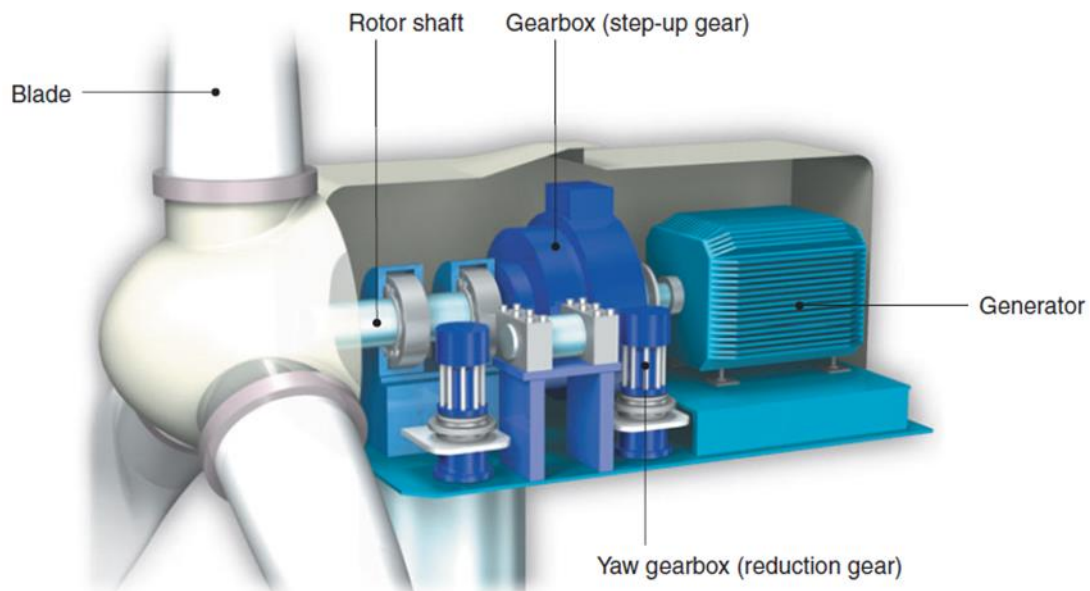

Figure 1. Nacelle of wind turbine [7]



Figure 2. Examples of WECs found in WTGB [8][9]

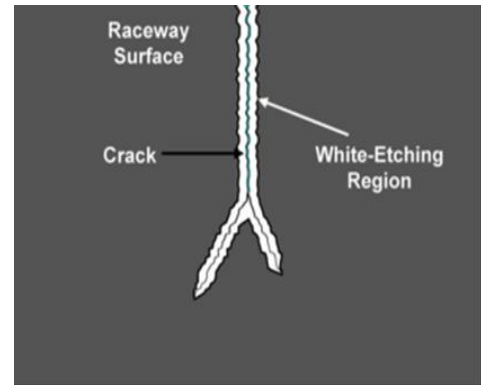

Figure 3. Schematics of WECs [10]

2. Methodology

Multiple criteria decision making “MCDM” is a tool and sub-discipline regarding the operation research which indicates an optimal and unique solution for the problem. The decision maker preferences are used to differentiate between solutions as well as to “trade-off” certain elements of criteria and sub-criteria. MCDM takes into account contradictory points of view and gives the decision maker tools to solve the complex decision problems dynamically [11]. In other words, MCDM is a consistent family of criteria F and a set of actions/variants/solutions A . In common decision-making processes eight steps are followed as presented in (figure 4). Analytic Hierarchy Process (AHP) is the most common methods among several decision-making methods [12]. As the first method is more popular and effective, it has been used to determine the most efficient options of wind turbine gearbox bearings taking in consideration different criteria and solutions.

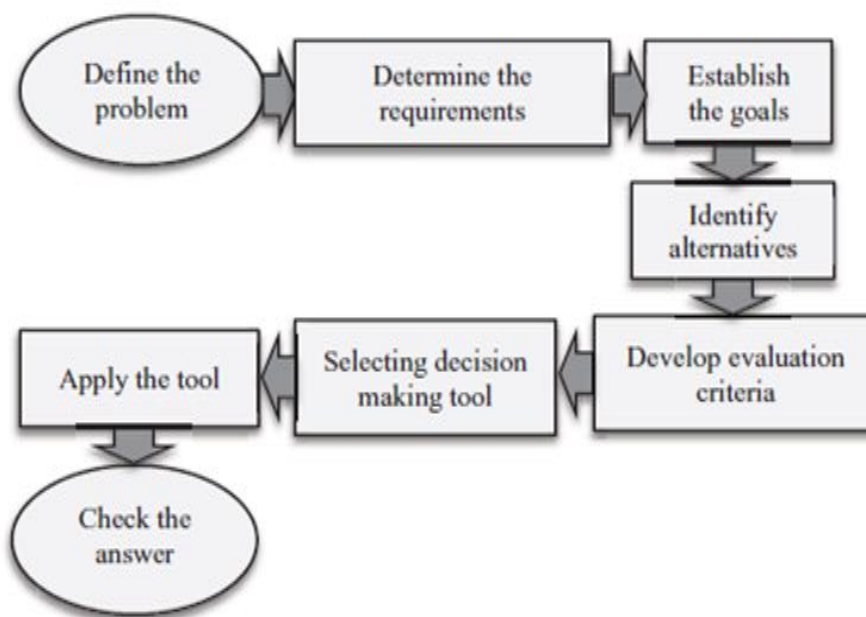

Figure 4. General decision making process [12]

2.1. Analytic Hierarchy Process “AHP”

MCDM approach of Analytic Hierarchy Process (AHP) was introduced by Saaty (1977). He edited more than 30 books regarding the topic. There are more than 900 books, scientific work papers and PhD theses which have deal with this method. It is an effective tool that may aid the decision maker to take the best compromise decision. Series of pairwise comparison matrixes behind reducing complex decision followed by synthesizing the results. In addition, AHP captures criteria and alternatives of the problem and indicates the degree of decision maker constituency. As a result, the bias in the process of decision making would be reduced. The weighting criteria of AHP is judgmental and based on preference of decision maker. It can be clearly noted that in subjective problems, the accuracy in this method can be considerably varied[12]. AHP algorithm is the important element to investigate the consistency level. When the consistency index CI calculated, the preferential information given by the DM is so consistent [13].

2.2. Expert Choice Software “EC”

Expert Choice “EC” software is a tool to find a compromised decision for multi-criteria problem. It has been created by (Saaty and Forman in 1983) to implement the Analytic Hierarchy Process (AHP) and has been used in different fields such as manufacturing, agriculture, environmental management and shipbuilding. Expert Choice Solutions (EC) combine proven mathematical techniques and collaborative team tools to enable the team obtaining the best decision in reaching a goal. Using AHP aids to structure the complexity and measure the competing of objectives with alternatives according to the degree of importance.

The overall steps of AHP and EC are as follows:

- structure a hierarchical Model;
- pairwise comparison for the criteria and sub-criteria according to their importance in the decision with respect to the main goals of study;
- pairwise comparison for the alternatives with respect to the criteria. The alternatives have to be assessed using one of the following tools: entering the priorities, utility curves or rate function;
- perform the analysis of sensitivity after synthesizing to determinate the best alternative.

The start point is objectives to main criteria and sub-criteria to select the best solution. It means that the decomposition sequence is implemented starting from the top to the bottom of the hierarchy structure problem [9]. In order to determine the relative importance of each alternative in terms of each criterion, pairwise comparisons are useful to be used. The decision-maker opinion has to be expressed as a value for each one pairwise comparison during the process at a time. The intensity of importance is scaled from (1-9) as shown in (table 1) [14].

2.3. Steps for using EC software

Start-up your EC program, then create (new model) and describe the goal of your work. You can choose the display mode (for example tree mode), then input the main criteria. For each main criterion, input their sub-criteria (if exist). As well, build up the comparison matrixes for (main criteria with each other, sub-criteria with each other) by activating (pairwise order from edit list). Then input the available alternatives (variants) and build up the comparison matrixes for (each variant with criteria and sub-criteria) by activating (pairwise order from assessment list). Finally, find your results from (sensitivity graphic) list.

Note that: the number of all comparison matrixes = A + B + C where;

A: number of criteria

B: number of sub criteria groups

C: SUM of (sub criteria units + criteria units that have not sub criteria).

Table 1. Scale of Relative Importance (according to Saaty 1983) [15]

Intensity of Importance	Definition	Explanation
1	importance is equal	two activities having the same contributions to the objective
3	importance is weak of one activity over another	experience and judgment are slightly favor one activity over another
5	importance is strong or essential activity	judgment experience is strongly favor one activity over another
7	importance is demonstrated	an activity is strongly favored, and its dominance has been demonstrated in practice
9	importance is an absolute	the evidence of one activity is favoring over another has the highest order of affirmation
2,4,6,8	in-between values judgments	it needs for compromising
reciprocals of above nonzero	if the activity (i) has nonzero numbers assigned to it throughout comparing with activity (j), then the later when compared with (i) has the reciprocal value.	

3. Applying AHP

3.1. Problem modeling

In this approach, as a part of structuring the decision problem, the problem should be structured into a hierarchical model. The relation between goals, criteria and alternatives must be shown by the model. The below structure (figure 5) is the hierarchy arrangement of the three levels as the first step to build the process of using AHP method.

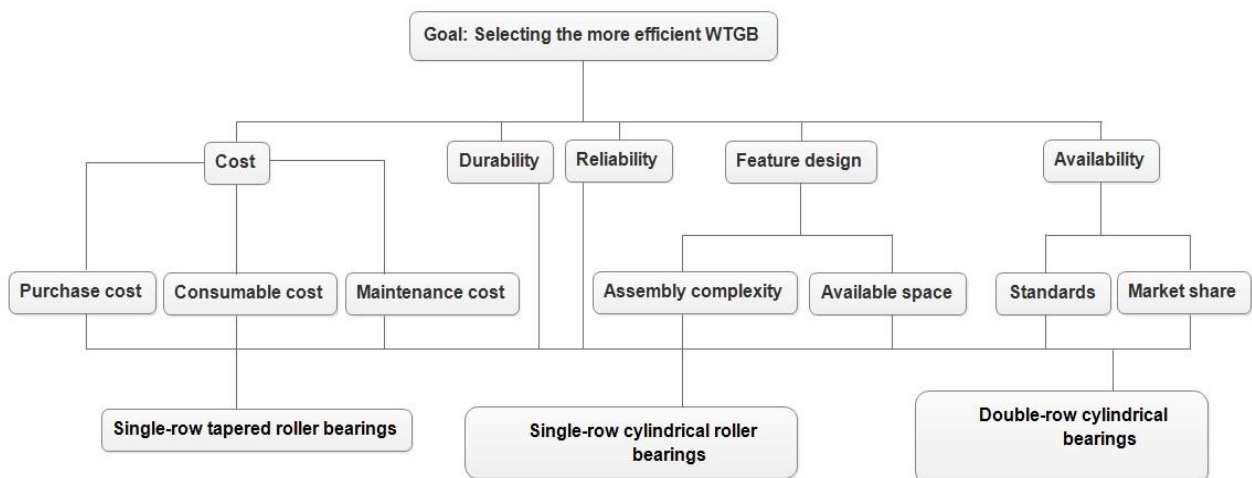
**Figure 5.** structure of selecting the more efficient WTGB [Researcher]

3.2. Variants (Alternatives)

Single-row tapered roller bearings

Single-row tapered roller bearings have the capability of taking high radial and axial loads in a single direction. These bearings are designed to withstand combined loads, i.e. simultaneous acting of radial and axial loadings. The projection lines of the raceways meet to provide a true rolling action at the location of common point on the bearing axis. So that the friction moment is low during operation. because of increasing the value of the contact angle α , the tapered roller bearing axial load capacity will be increased consequently. The angle of contact value is about ($10^\circ - 30^\circ$) (figure 6). The optimized roller end design promotes lubricant film thickness, resulting in lower friction and reduces wear and frictional heat. The bearings can run at reduced noise levels and better maintain preload.

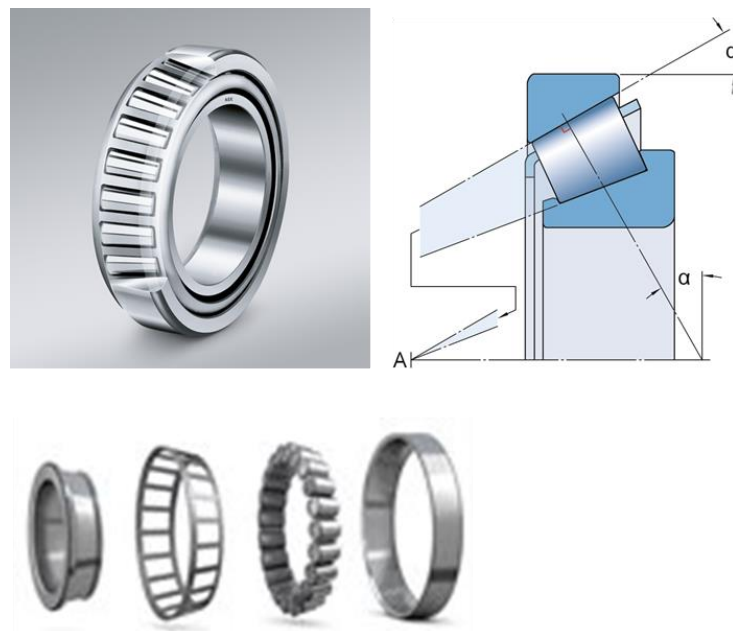

Figure 6. tapered roller bearing , α : contact angle [16]

Single-row cylindrical roller bearings

Single-row cylindrical roller bearings have a large area of contact with the inner race. They can distribute loads across a broader surface. So that, these type of bearings are suitable for high speeds and have high radial load capacity [17]. The bearings are characterized by high speed capability, low-friction and high radial load capacity. Because of the distributed load over a larger contact area, the bearing can carry a greater load (figure 7).

Double-row cylindrical roller bearings

Double-row cylindrical roller bearings have high radial rigidity. The difference with single row bearings is that they have two sets of inner and outer rings with two sets of rollers and cage. As their magnified strength, enhanced carrying capacity and increased accuracy, the type is used in precision machines because of their magnified strength (figure 8).



Figure 7. Single-row tapered roller bearing [18]

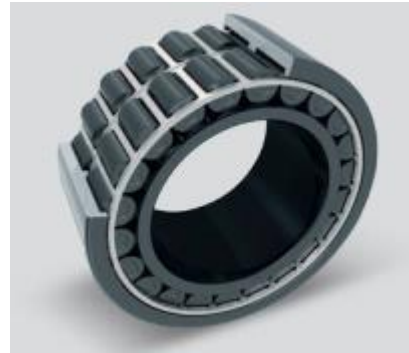

Figure 8. Double-row cylindrical roller bearings [19]

3.3. Criteria (Objectives)

Before listing the main recommended criteria to select the suitable bearing of wind turbine gearbox, it is assumed that all the presented variants have belonged to the same manufacture under the same grade of the following criteria: -

- Material (raw material and material microstructure including the content of inclusions with voids i.e. material cleanliness);
- Methods of manufacturing and heat treatment (cutting, hardening, rolling, turning, surface finishing).

The three mentioned alternatives have the same ranking level of the above two criteria which means that these criteria have to be omitted. The following objectives are considered as reference units for weighting the mentioned variants according to the main goal: -

1. Cost (initial buying, Consumable & maintenance),
2. Durability (no. of safe rotating cycles),
3. Reliability,
4. Feature of design (assembly complexity & available space)
5. Existence / Availability (standards & market share)

Cost

This criterion includes (initial buying, consumables and replacement maintenance) cost of wind turbine gearbox bearings.

- Initial buying cost

Initial buying cost depends on many factors like (manufacturing brand, bearing design, repetition of failure). Inductive Failure Analysis (FMEA) helps to identify potential failure modes taking into consideration previous experience with similar products or the logic common failure mechanism. It enables the team to characterize those failures with the minimum effort and this reducing development costs and time. The total cost over could be calculated by the sums of all expenses during its lifespan. As a result, the overall costs can be divided into three groups: total manufacturing costs, capital costs and operation and maintenance (O&M) [20].

- Consumable Cost

WTGBs have subjected to high friction especially at the high-speed stages which leads to increase temperature. As a result, high quality of specific lubricant has to be used for this purpose. In addition to lubricant cost, the consumable cost of WTGB includes the overall cost of bearing fittings. However, each types of bearings have required specific grade of consumables in very variant costs.

- Repairing and replacement (Maintenance Cost)

Most types of WTGB need to be repaired or replaced during (2-5) years of being in operation before at least 15 years of its experimental and calculated lifespan. This is what has been called “premature

failure". The problem would be more complicated for offshore wind turbines because of the severe operational logistic conditions comparing to onshore type.

Durability (no. of safe rotation cycles)

"Rating life" is an indicating to the life of bearing calculated for 90% reliability. It is a predicted value based on a rated dynamic radial (or axial) loading [21]. It gives the amount of time that a group of apparently identical. It can be considered as a primary representation of the bearing suitability.

According to the British Standards (BS ISO 281:2007), the base rating life can be calculated for (radial and thrust ball bearings, radial and thrust roller bearings) [21].

- 1- The ball bearing basic rating life is given by the equation:

$$L_{10} = \left(\frac{C_r}{P_r}\right)^3 \quad (1)$$

- 2- The thrust ball bearing basic rating life is given by the equation:

$$L_{10} = \left(\frac{C_a}{P_a}\right)^3 \quad (2)$$

- 3- The radial roller bearing basic rating life is given by the equation:

$$L_{10} = \left(\frac{C_r}{P_r}\right)^{10/3} \quad (3)$$

- 4- The thrust roller bearing basic rating life is given by the equation:

$$L_{10} = \left(\frac{C_a}{P_a}\right)^{10/3} \quad (4)$$

Where,

L_{10} : basic rating life (million cycles)

C_r : basic rated dynamic radial load (newton)

P_r : dynamic equivalent radial load (newton)

C_a : basic rated dynamic axial load (newton)

P_a : dynamic equivalent axial load (newton)

Existence / Availability

It includes two parameters; (availability of standards & Market share) as follows:

1. Availability of standards: Bearings are manufactured and then tested using standards developed by a range of societies and associations. The most familiar standards are American National Standards Institute, International Organization for Standardization and Antifriction Bearing Manufacturers Association. If the presented design has not matched with the mentioned standards and not available in terms of standardization criteria, it will minimize the importance value of the bearing.
2. Market share: As the required bearings are more specific, there is great disparity of their market share. Sometimes, there is a need to buy a customized bearing for more specific conditions. In urgent cases it is so important to find the required suitable bearing during short period of time which has a direct relation with their availability in the market.

3.4. Pairwise comparison and synthesizing of analysis

Applying EC software with the output results have been shown with more details in figures (9-27). They can be classified into three groups as follows:

In order to realise the overall matrix figures (9-21), the following notes have to be taken in consideration:

- 1- the comparison scale has graduated from (0-9).
- 2- red colour number means that (row element is stronger than the column one).

3-do not take into consideration the yellow rectangular. It is a pointer location.

4-the value of (consistency index CI) indicate the logical degree of comparison process. The more logical comparison the nearest value to (0.0). It should not exceed (1.0) i.e. the acceptable range of CI is ($0.0 < CI < 1.0$). As a result, all pairwise comparison results of the mentioned figures are logical.

5-all comparison values have been indicated according to the decision maker requirements with respect to the main goal of the problem.

4. Discussion of results

The following items give more explanation about figures (9-27) as follows: -

- (figures 9-21): referring to the hierarchical model structure (figure 5), the comparison matrix figures (9-21) can be classified into three groups:
 - a) (figure 9): comparison matrix for the main criteria with respect to goals. For example, reliability is more important than cost by (4.0).
 - b) (figures 10-12): comparison matrix for the sub-criteria to their main criteria. For example, (figure 10) shows that purchase cost is more important than consumable cost by (2.0).
 - c) (figures 13-21): comparison matrix for the variants with respect to each main and sub-criteria element. It so important to mention that if the main criteria have sub-criteria elements' branches, the pairwise comparison of variants should be occurred with respect to each one of the sub-criteria elements but not with their main criteria. For example, (figure 13) shows that single-row cylindrical roller bearing is better than double-row cylindrical roller bearing in terms of (purchase cost) by (3.0).
- (figure 22): it shows that comparison process is fully completed. Each group of (main criteria, sub-criteria and variants) has portions summation of (1.000).
- (figures 23-27): The final results can be synthesized in different forms of sensitivity graphs. They have clearly emphasized the optimum compromise solution is single-row tapered bearing. The overall resultant cost of (single-row tapered & single row cylindrical) bearings have convergent values but higher than (double-row bearing).

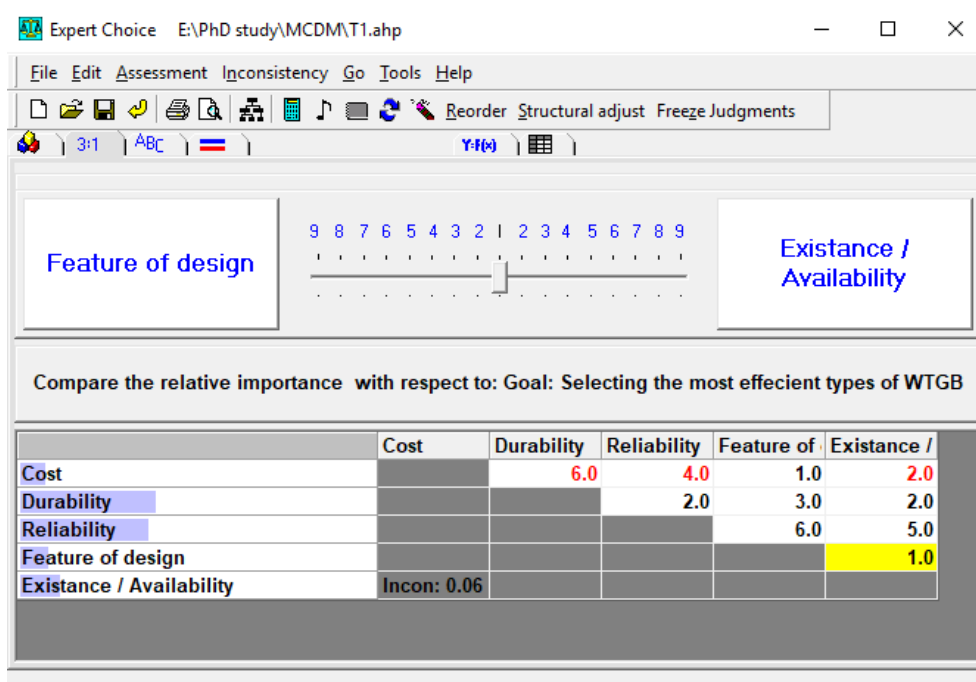

Figure 9. comparison of main objectives with respect to goals (Researcher)

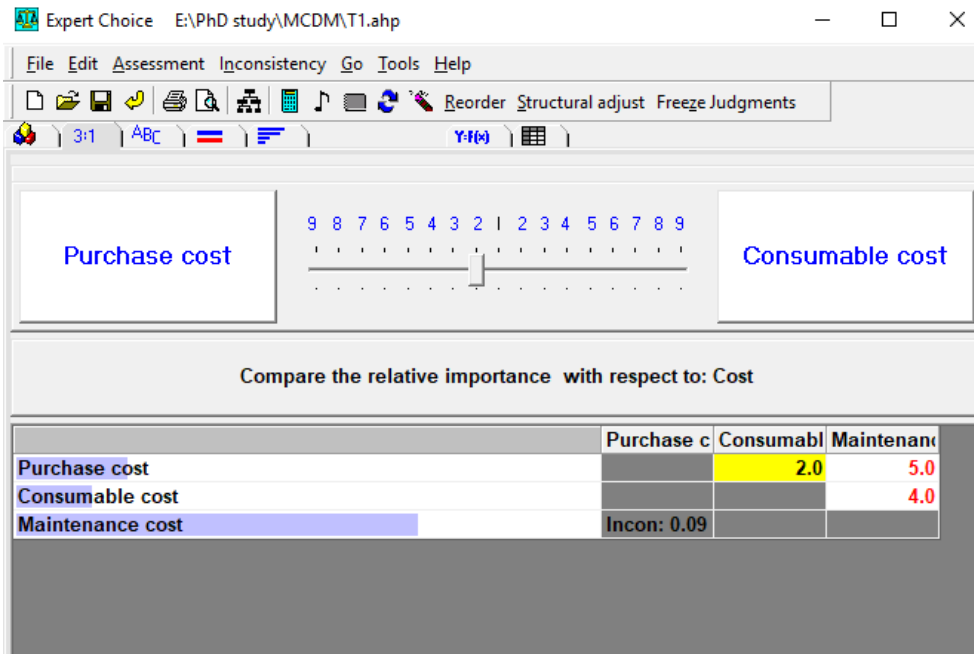

Figure 10. comparison of objectives with respect to goals (Researcher)

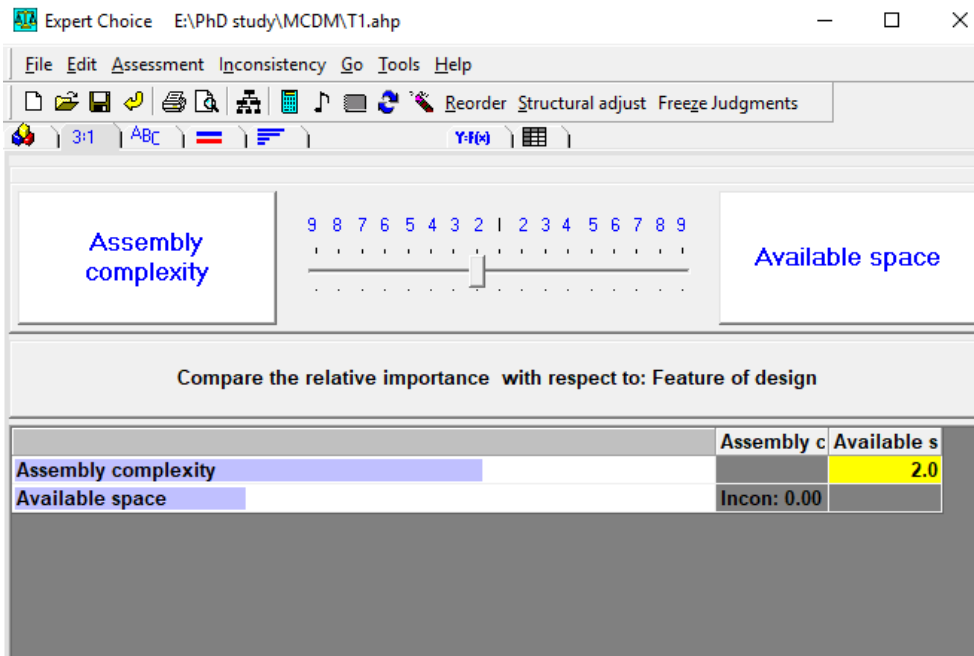

Figure 11. comparison of objectives with respect to goals (Researcher)

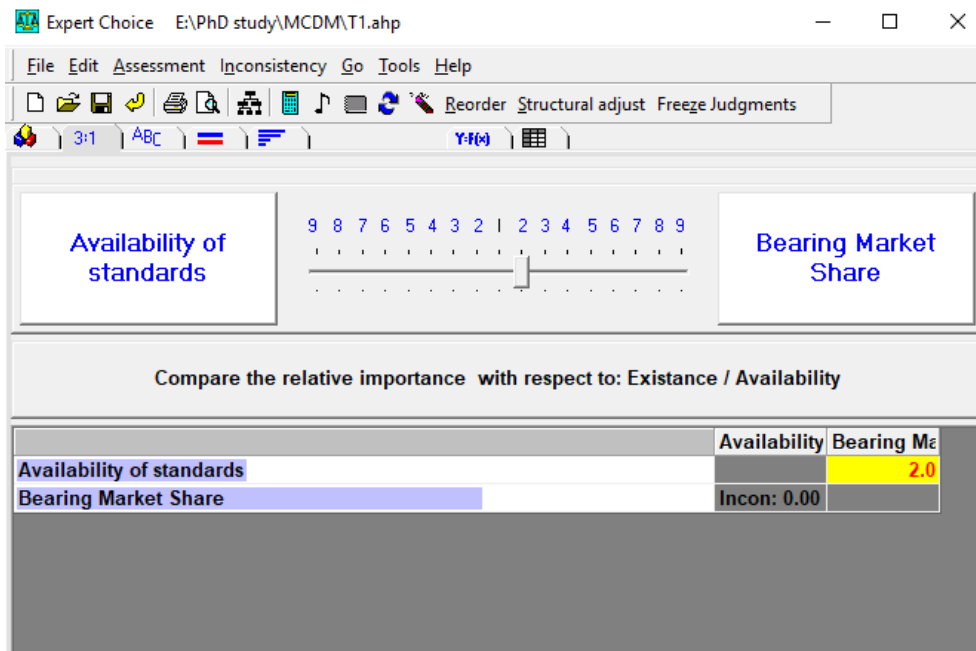

Figure 12. comparison of objectives with respect to goals (Researcher)

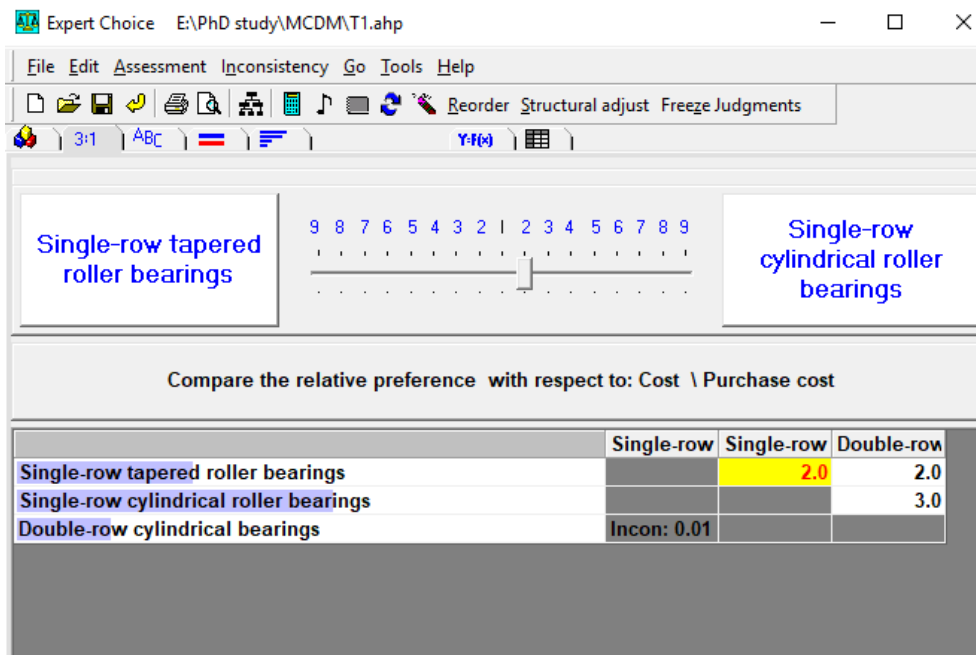

Figure 13. pairwise comparison of alternatives with respect to objectives (Researcher)

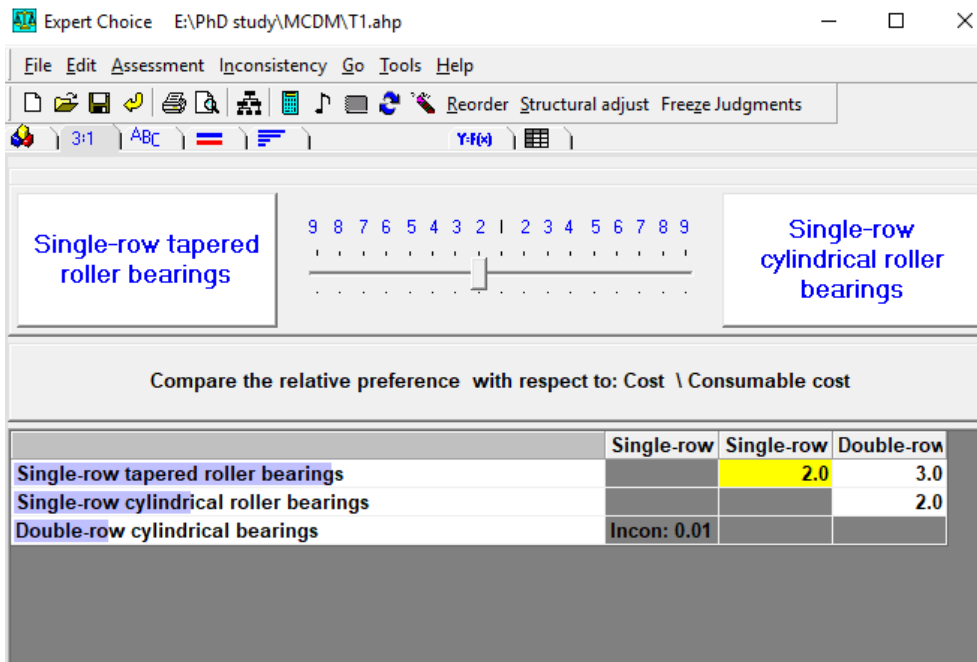

Figure 14. pairwise comparison of alternatives with respect to objectives (Researcher)

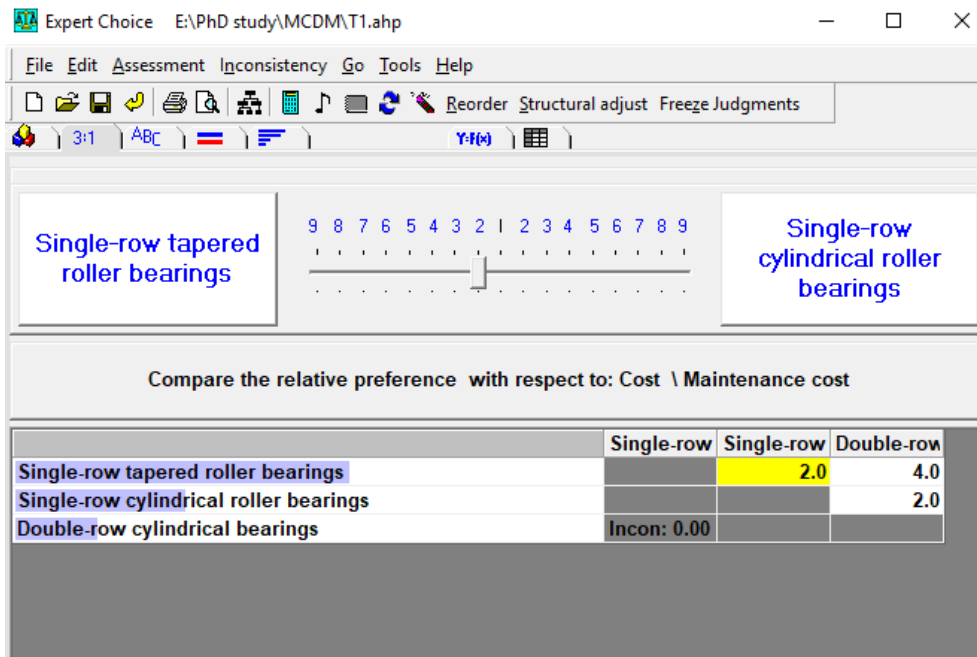

Figure 15. pairwise comparison of alternatives with respect to objectives (Researcher)

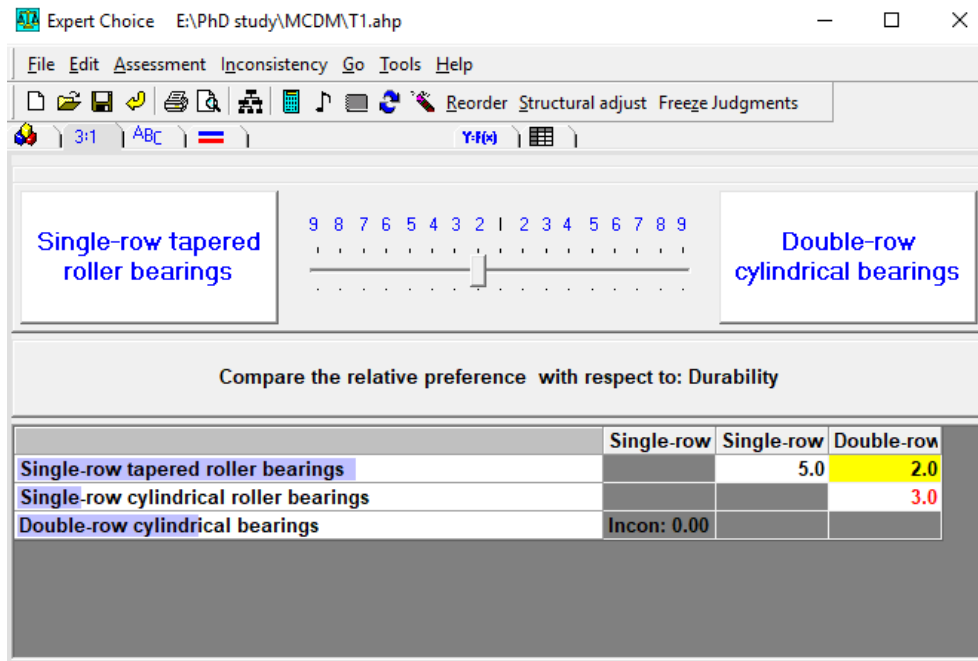

Figure 16. pairwise comparison of alternatives with respect to objectives (Researcher)

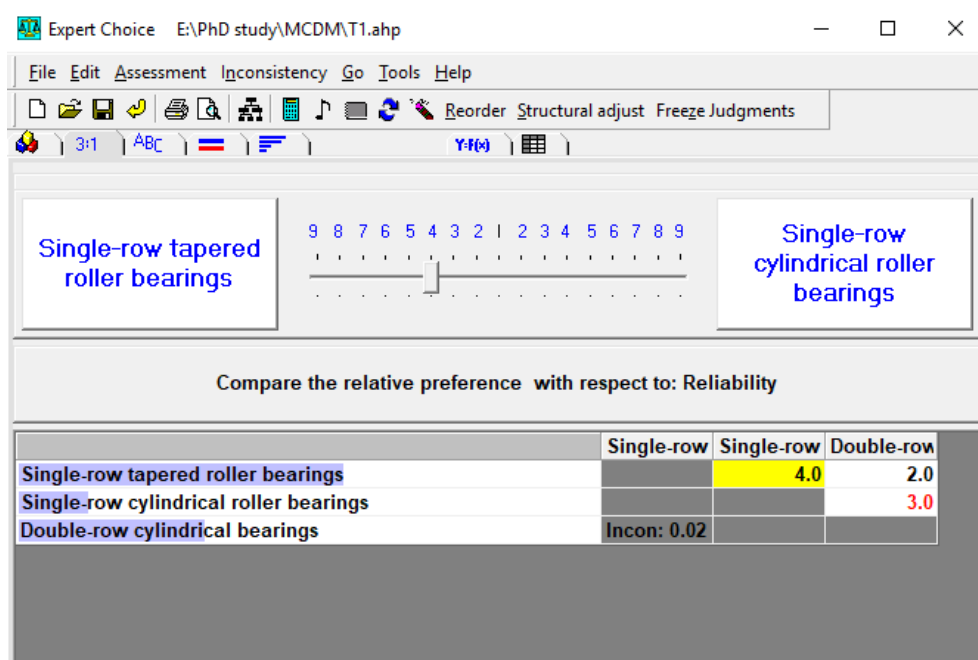

Figure 17. pairwise comparison of alternatives with respect to objectives (Researcher)

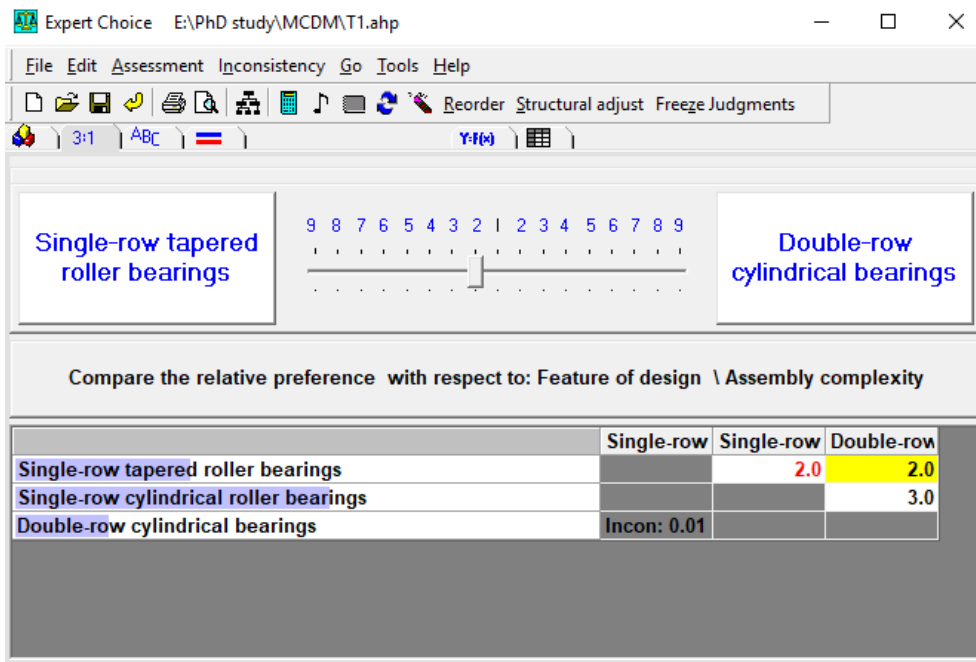

Figure 18. pairwise comparison of alternatives with respect to objectives (Researcher)

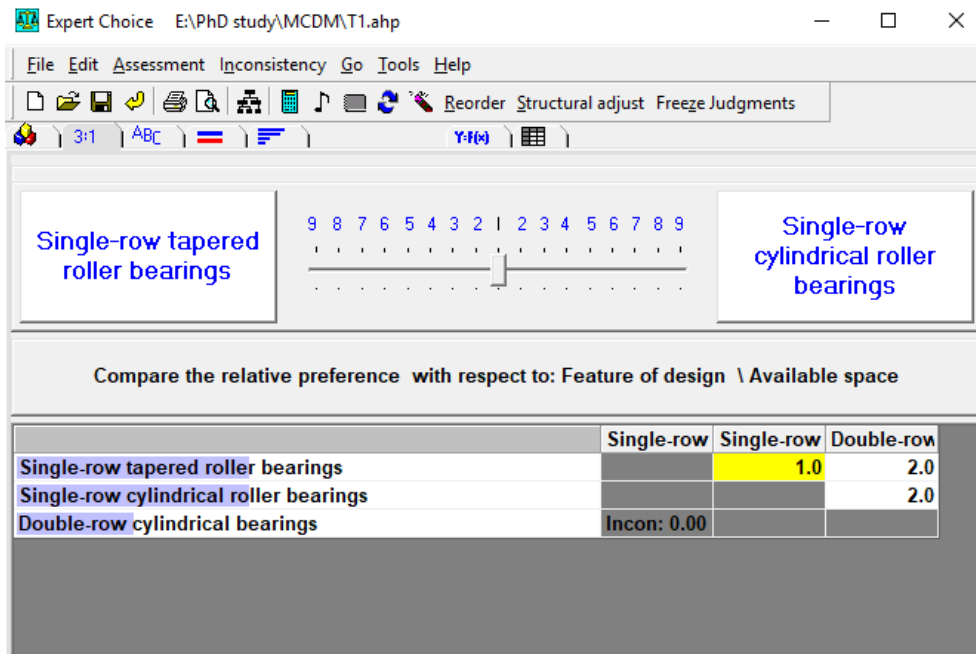

Figure 19. pairwise comparison of alternatives with respect to objectives (Researcher)

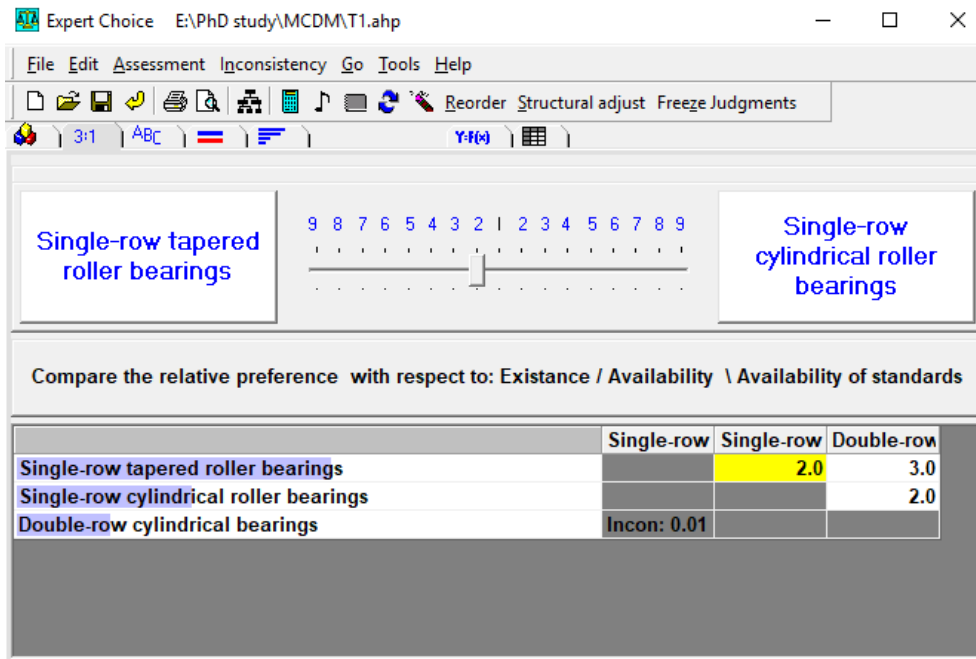

Figure 20. pairwise comparison of alternatives with respect to objectives (Researcher)

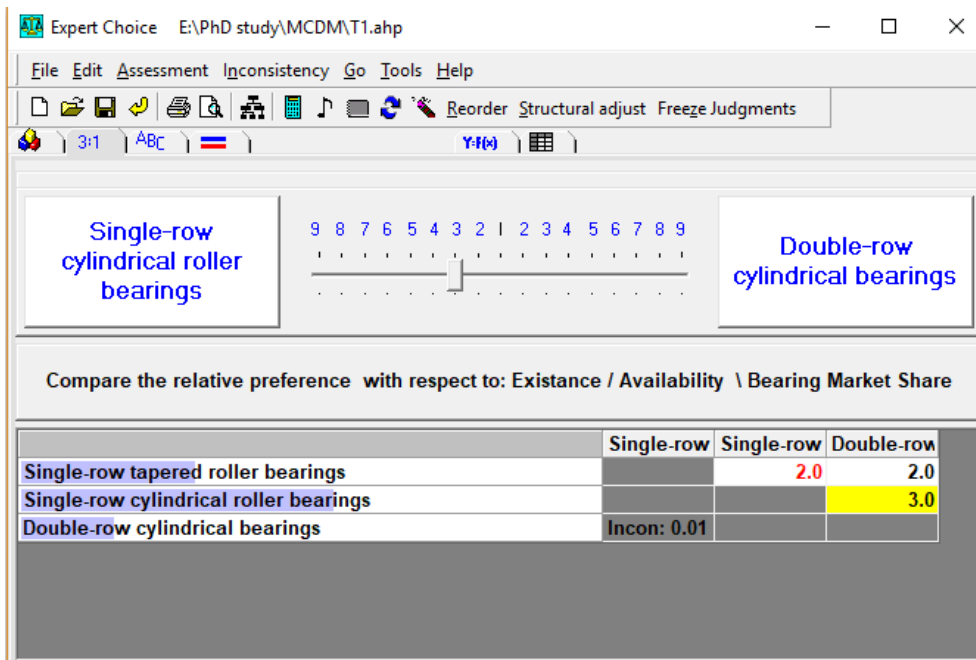

Figure 21. pairwise comparison of alternatives with respect to objectives (Researcher)

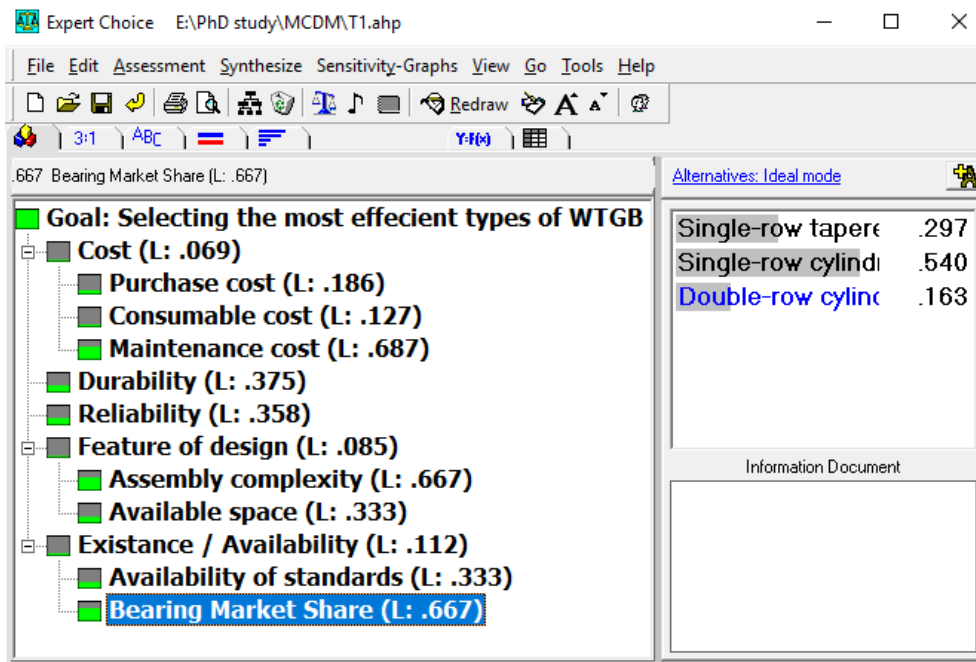

Figure 22. completing of pairwise comparison (Researcher)

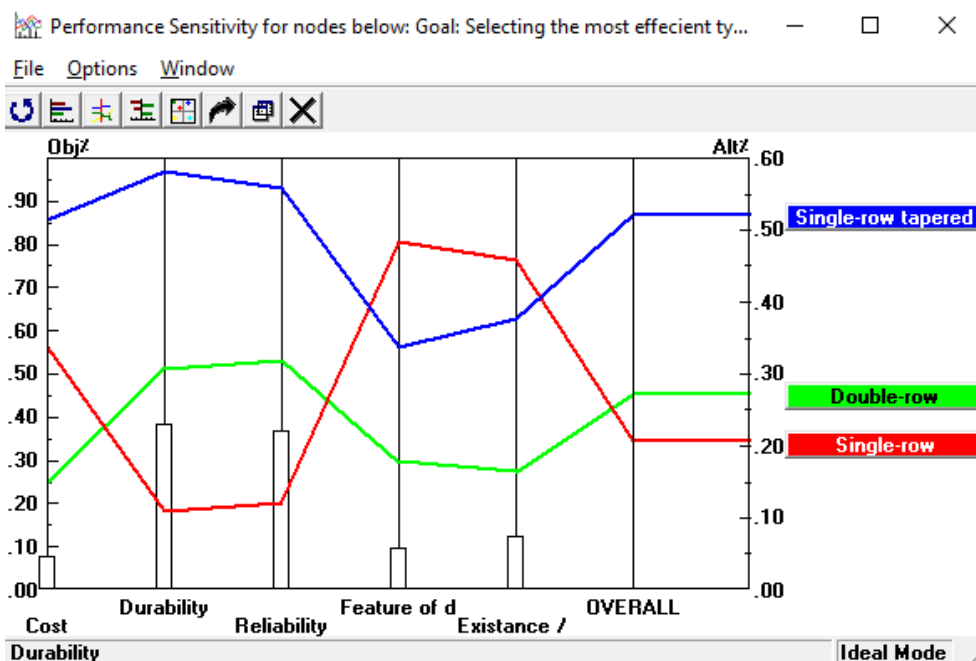

Figure 23. performance sensitivity (selecting the most efficient alternatives) (Researcher)

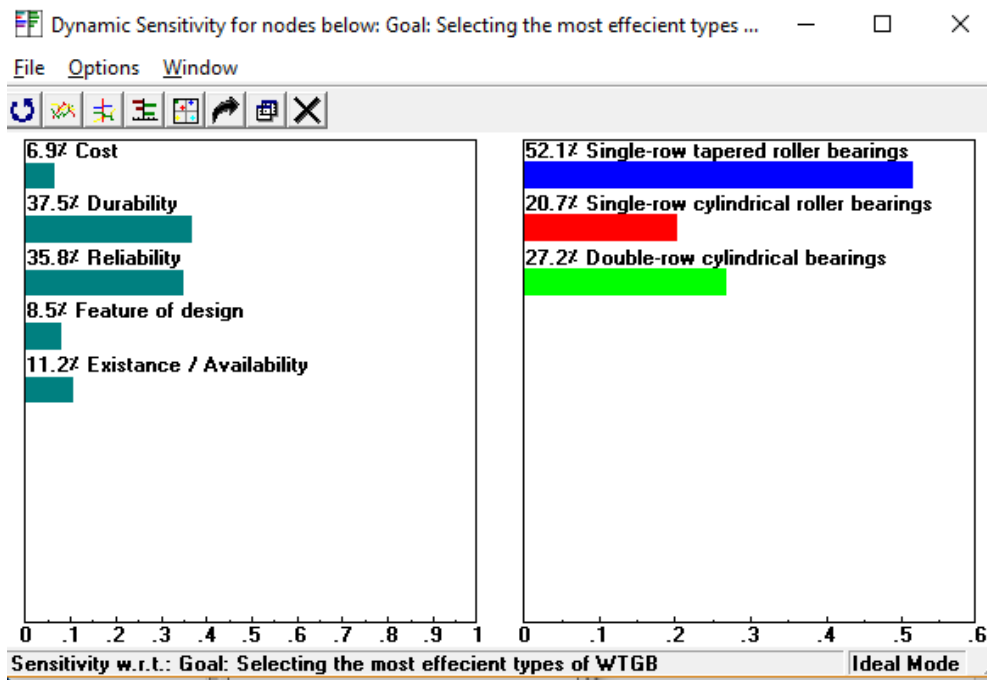

Figure 24. dynamic sensitivity (selecting the most efficient alternatives) (Researcher)

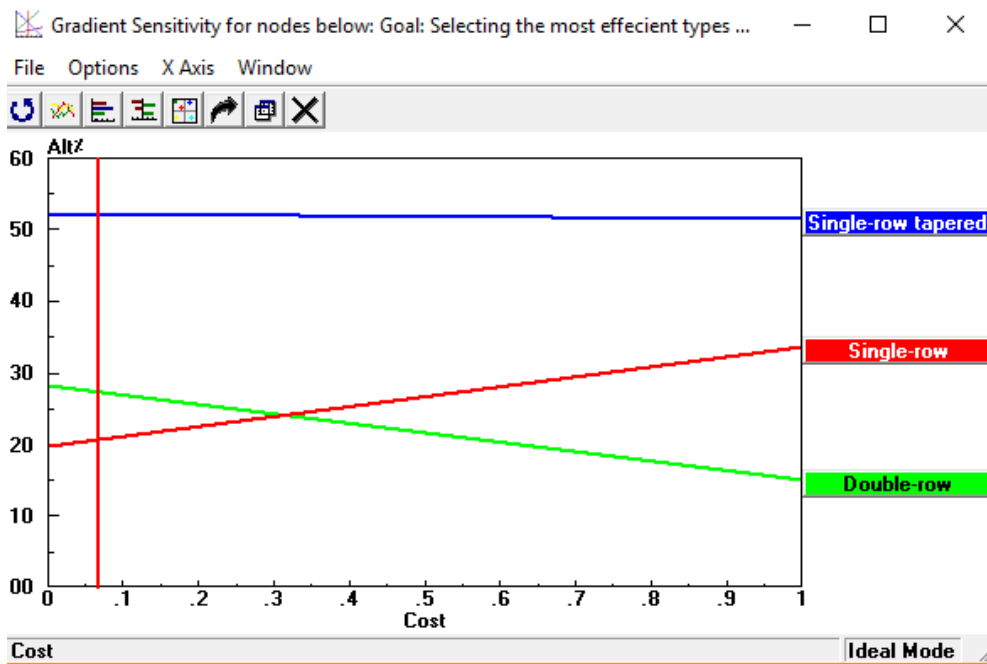

Figure 25. gradient sensitivity (selecting the most efficient alternatives) (Researcher)

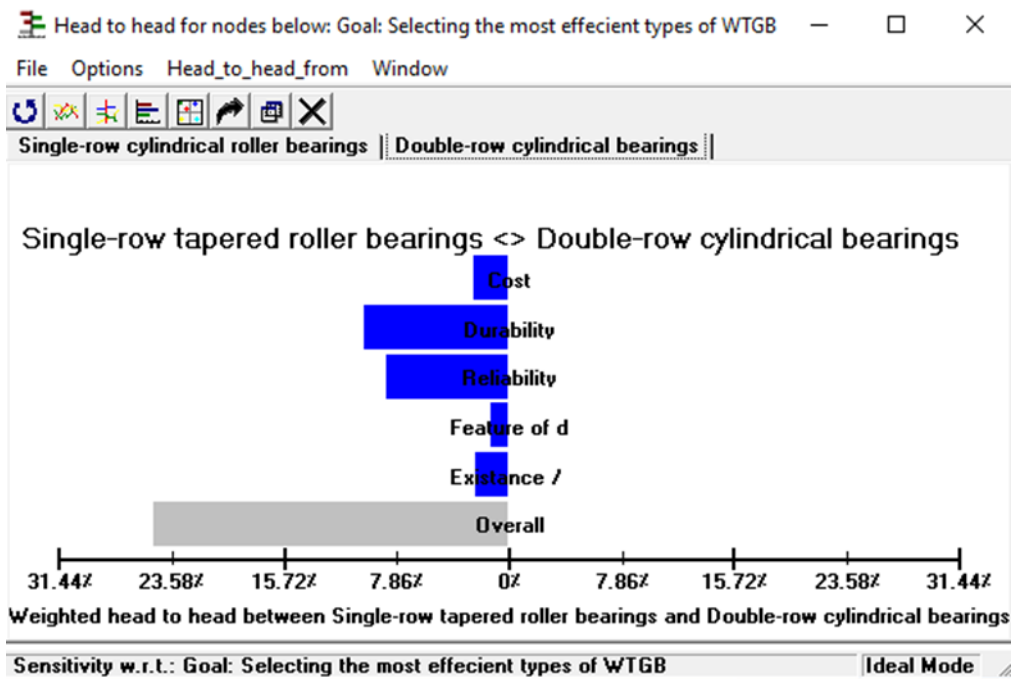

Figure 26. head to head (selecting the most efficient alternatives) (Researcher)

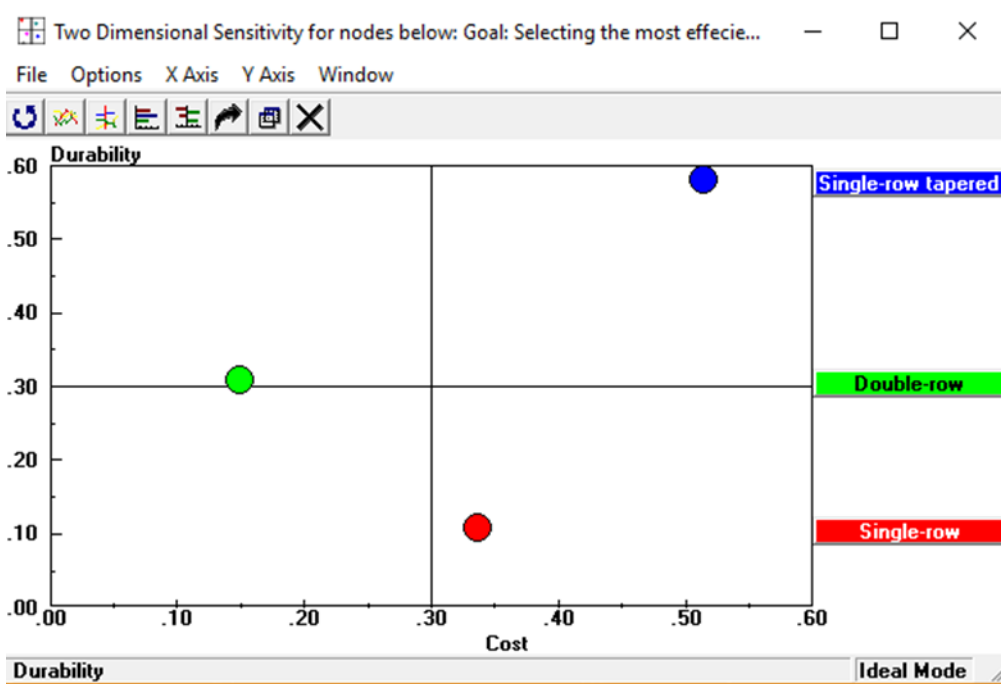

Figure 27. two-dimensional sensitivity (selecting the most efficient alternatives) (Researcher)

5. CONCLUSIONS

“Expert Choice EC” software is an active tool to choose the optimised and compromised solution among different variants in terms of varying criteria. As an application for “EC”, it has concluded that (single-row tapered roller bearing is the most efficient choice for using in wind turbine gearbox of about 52.1% than single and double-row cylindrical roller bearings). Obviously, the two prevalent criteria (durability 37.5% & reliability 35.8%) illustrated the logical outcomes where most of premature wind turbine breakdowns have executed by the lack of the two mentioned criteria.

References

- [1] J. K. Kaldellis and D. Zafirakis, 2011 “The wind energy (r)evolution: A short review of a long history,” *Renew. Energy*, **36**(7), pp. 1887–1901.
- [2] T. Bruce, *Analysis of the Premature Failure of Wind Turbine Gearbox Bearings*. 2016.
- [3] K. Stadler and A. Studenrauch, 2013 “Premature bearing failures in wind gearboxes and white etching cracks (WEC),” *SKF Evol.*, p. 7.
- [4] H. Long, R. S. Dwyer-Joyce, and T. Bruce, 2015 “Dynamic modelling of wind turbine gearbox bearing loading during transient events,” *IET Renew. Power Gener.*, **9**(7), pp. 821–830.
- [5] M. H. Evans, L. Wang, H. Jones, and R. J. K. Wood, 2013 “White etching crack (WEC) investigation by serial sectioning, focused ion beam and 3-D crack modelling,” *Tribol. Int.*, vol. **65**, pp. 146–160.
- [6] J. Ukonsaari, “Maintenance Effect On Present And Future Gearboxes For Wind Turbines,” *Energiforsk*, 2016.
- [7] S. Yagi, 2004 “Bearings for Wind Turbine,” *Tech. Rev.*, no. 71, pp. 40–47.
- [8] B. Gould, A. Greco, K. Stadler, and X. Xiao, 2017 “An analysis of premature cracking associated with microstructural alterations in an AISI 52100 failed wind turbine bearing using X-ray tomography,” *Mater. Des.*, Vol. **117**, pp. 417–429.
- [9] “<https://www.slideshare.net/PerryThiessen/wind-turbine-reliability-condition-monitoring>.” .
- [10] M. Grujicic, V. Chenna, R. Galgalikar, J. S. Snipes, S. Ramaswami, and R. Yavari, 2014 “Wind-Turbine Gear-Box Roller-Bearing Premature-Failure Caused by Grain-Boundary Hydrogen Embrittlement: A Multi-physics Computational Investigation,” *J. Mater. Eng. Perform.*, Vol. **23**(11), pp. 3984–4001.
- [11] P. J. ŽAK, *Multiple Criteria Decision Making / Aiding in Transportation & Logistics*. Australia and New Zealand ; July-August 2011.
- [12] D. Sabaei, J. Erkoyuncu, and R. Roy, 2015 “A review of multi-criteria decision making methods for enhanced maintenance delivery,” *Procedia CIRP*, Vol. **37**, pp. 30–35.
- [13] prof. dr hab. inż. J. Żak, “MCDM/A lecture - PhD level - PUT - Poland,” pp. 2–36.
- [14] P. Adamović, Č. Dunović, and M.-M. Nahod, “*Expert Choice Model for Choosing Appropriate Trenchless Method for Pipe Laying*.”
- [15] I. Engineering, E. Triantaphyllou, and S. H. Mann, 1995 “Using the Analytic Hierarchy Process for Decision Making in Engineering Applications : Some Challenges,” *Int. J. Ind. Eng. Theory, Appl. Pract.*, **2** (1), pp. 35–44.
- [16] “<http://www.nsk.com/industries/wind.html>.” .
- [17] “SKF cylindrical roller bearings - always in the lead Contents,” *SKF INSOCOAT*, 2004.
- [18] “<http://www.skf.com/group/products/bearings-units-housings/roller-bearings/cylindrical-roller-bearings/single-row-cylindrical-roller-bearings/index.html>.” .
- [19] “https://www.schaeffler.com/remotemedien/media/_shared_media/08_media_library/01_publications/schaeffler_2/brochure/downloads_1/pwe_de_en.pdf,” p. 8.
- [20] G. Puglia, 2013 “Life cycle cost analysis on wind turbines,” p. 73.
- [21] International Organization for Standardization, “*ISO 281:2007 Rolling bearings - Dynamic load ratings and rating life*,” Vol. **3**, no. May, 2016.

Acknowledgments

The team work would like to thank (Faculty of Transport Engineering / Poznan University of Technology) to facilitate all related requirements of this research. Sincere gratitude to (prof. **Dr. hab. inż. Stanisław LEGUTKO**) for his patience, motivation, and immense knowledge to supervise this work.